

AUTO LENS EDGER

LE-300/LE310/310P/320/400/420 MANUAL

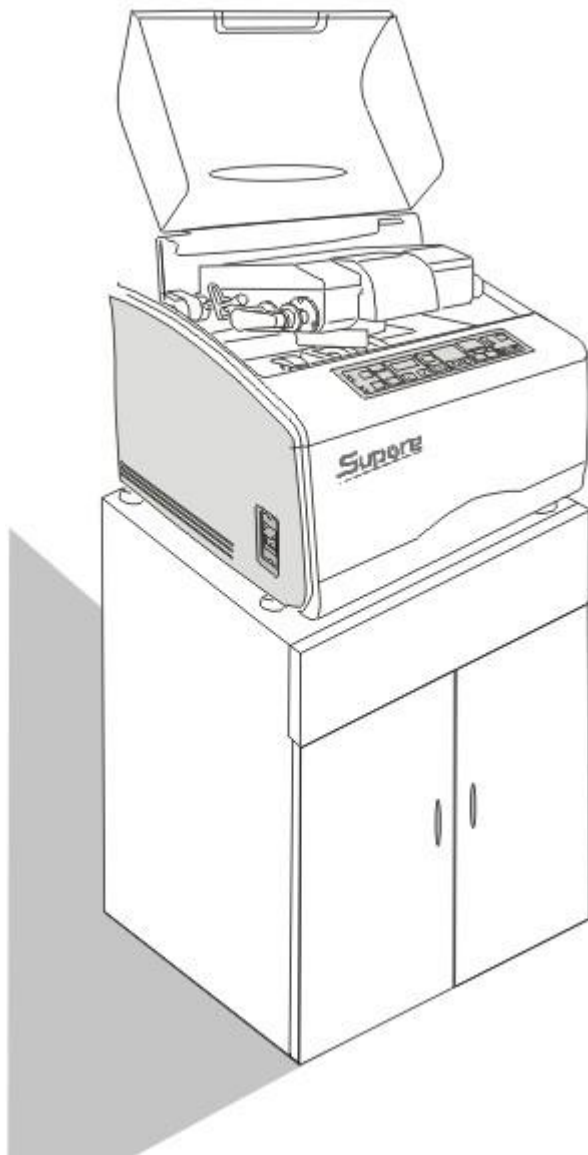

PREFACE

Introduction of product:

According to the material of lens(GL,CR,PC),size of lens,lens type(square lens samll size,right angle lens etc.), lens edge(flat,beveling)etc,

Control by the electronic circuit to edging lens same as the mould.

Safe information:

1、 INTRODUCTION OF SECURITY SYMBOL

 This signal means the aim of alert(involving notes),and special alerts are marked in it.

 The signal means forbidden operations(forbidden matters), and special forbidden content is marked inside or near it.

 The signal means operations that must be carried out, and special explanations are marked in it.

2、 ENVIRONMENT OF USE

(Avoid such harmful conditions below:)

- | | |
|------------------------------------|----------------------|
| A.temperature out of desired scope | B.sharing wire board |
| C.violent shake | D.sunlight |
| E. dust/fog | F.moisture |

3、 ATTENTION:

A. Don't crash machine suddenly.

B. Don't press the button violently.press in gentle is preference.

C. Don't lean against the machine. The fallen of the machine may cause injury.

D. Use dry cloth or wrenched wet clothing liquid to clean the outside cover and keyboard.Cut off the power, and clean the fac of the machine after daily work.

E.Don't use any corrosive material or volatility liquid to clean the machine.

 Forbidden

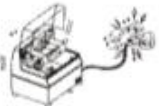

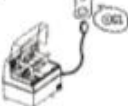

■ Don't insert or remove power plug with wet hand. Or it may cause an electric shock.

 Unformulated AC voltage is forbidden





■ No rating marked DC voltage is forbidden to use. Otherwise it may fire or electric shock.

 Forbidden





■ If the machine shares one wire board with other high-power machines it may cause voltage fluctuation every time the machine used, which may cause malfunction to machine. Make sure one single wire board supplying electricity to the machine.

 Forbidden





■ Metal and water container such as flower vase, flowerpot and cup are forbidden to put on the machine. Any metal or fluid entering the machine may cause fire or electric shock.

 Grounding wire





■ Make sure the machine is well connected to the earth, and the same is the outside wire. The irrelevancy connection may cause fire or electric shock.

 Forbidden





■ Don't abrade, damage or change the machine wire, and don't put heavy substance over power line. Over dragging or curving wire may cause fire or electric shock.

 Remove the plug





■ If the machine falls down or the outside cover is broken, cut off the power firstly and remove power plug from wire board. Then, call Supore agency (or Supore post sales service center). If continually using the machine in such case, it may cause fire or electric shock.

 Remove the plug





■ Longtime using of machine may cause abnormal cases, such as smoke, smell, fire or electric shock. The power must be cut off and the plug must be removed from wire board in such case. Then, call Supore agency (or Supore post sales service center).

 Remove the plug



■ Make sure to hold the body of the plug while removing the plug from the wire board. Drawing the wire part may damage the wire or explore the iron inside, which may cause fire or electric shock.

 No disassembling



■ Do not disassemble, repair or modify the machine without permission. High pressure, overheat or sharpen materials may cause injury.

■ No modify without permission!

LIST

PREFACE	错误！未定义书签。
INTRODUCTION OF PRODUCTS	错误！未定义书签。
SECURITY INFORMATION	错误！未定义书签。
1、 INTRODUCTION OF SECURITY SYMBOL	1
2、 ENVIRONMENT	1
3、 POINTS FOR ATTENTION	2
ONE、 INTRODUCTION OF MACHINE	6
1、 LE-300/310/310P/ NOMENCLATURE	6
2、 LE-320/400/420 NOMENCLATURE	8
3、 LE-300/310/310P CONTROL PANEL	9
4、 LE-320/400/420 CONTROL PANEL	10
TWO、 OPERATION PROCEDURES	10
1、 INSTALLATION	10
A. INSTALLATION OF MAIN MACHINE	10
B. INSTALLATION OF WATER TANK AND PIPE	11
2、 DEBUGGING	13
3、 USE	14
4、 REGISTRATION OF WHEEL	错误！未定义书签。
A.USE IN THE FOLLOWING SITUATION ...	错误！未定义书签。

B.PREPARATION.....	错误！未定义书签。
C.REGISTRATION OF LENS SIZE.....	错误！未定义书签。
THREE、 MAINTENANCE.....	错误！未定义书签。
1、 ROUTINE MAINTENANCE.....	错误！未定义书签。
2、 CLEAR.....	错误！未定义书签。
3 、 POINT OF ATTENTION WHEN YOU MOVE THE MACHINE.....	错误！未定义书签。
4、 SERVICE INFORMATION.....	错误！未定义书签。
FOUR、 SIMPLE FAULT AND MAINTENANCE.....	错误！未定义书签。
1、 WHEEL DON'T MOVE AND NO WATER SUPPLY	错误！未定义书签。
2、 CONTINUS TO MAKE NOISE “Peep”.....	错误！未定义书签。
3、 OFF-CENTERING.....	错误！未定义书签。
4、 ABNORMAAL IN BEVERLING	错误！未定义书签。
FIVE、 CAPABILITY PARAMETER.....	错误！未定义书签。
SIX、 ASSESSORIES LIST.....	错误！未定义书签。

一、Introduction

1、LE-300/310/310P nomenclature

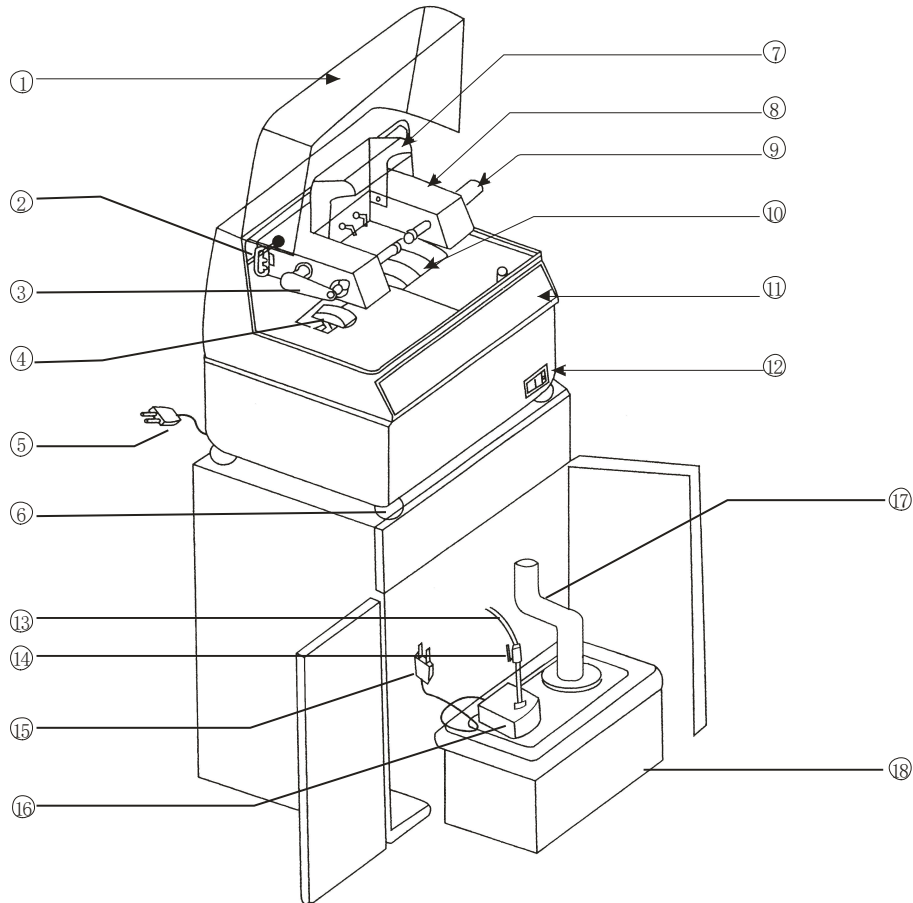

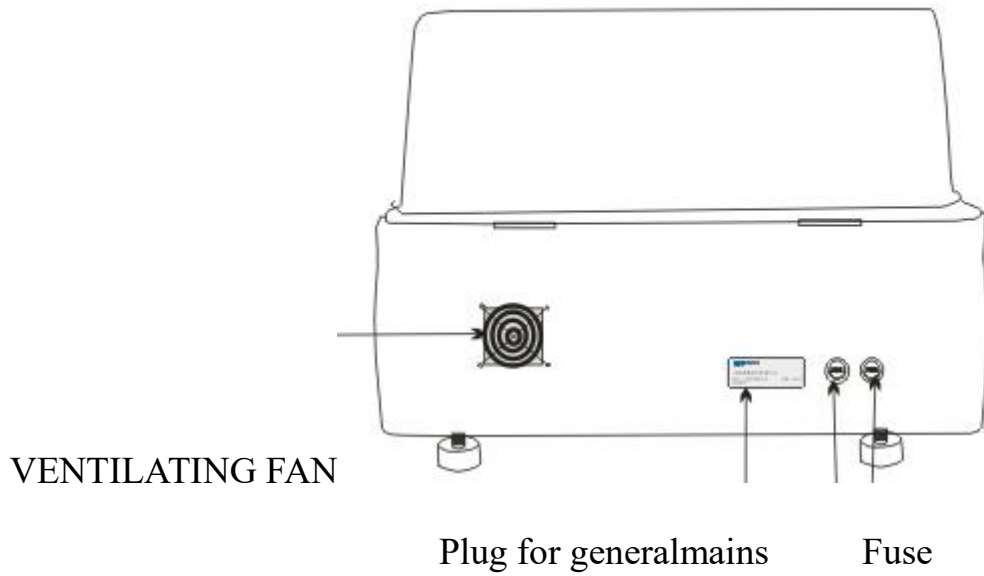

- (1) outside cover (2) carriage weight-changing lever
 (3) template retainer level (4) carriage backlashing

sensor

- (5) power cord (6) adjustable cover
 (7) waterproof cover (8) carriage
 (9) lens clamp (10) gear wheel
 (11) operation panel (12) on/off switch
 (13) water supply pipe (14) water supply cock
 (15) pump power cord (16) pump
 (17) drain pipe (18) tank

2、LE-320/400/420 nomenclature

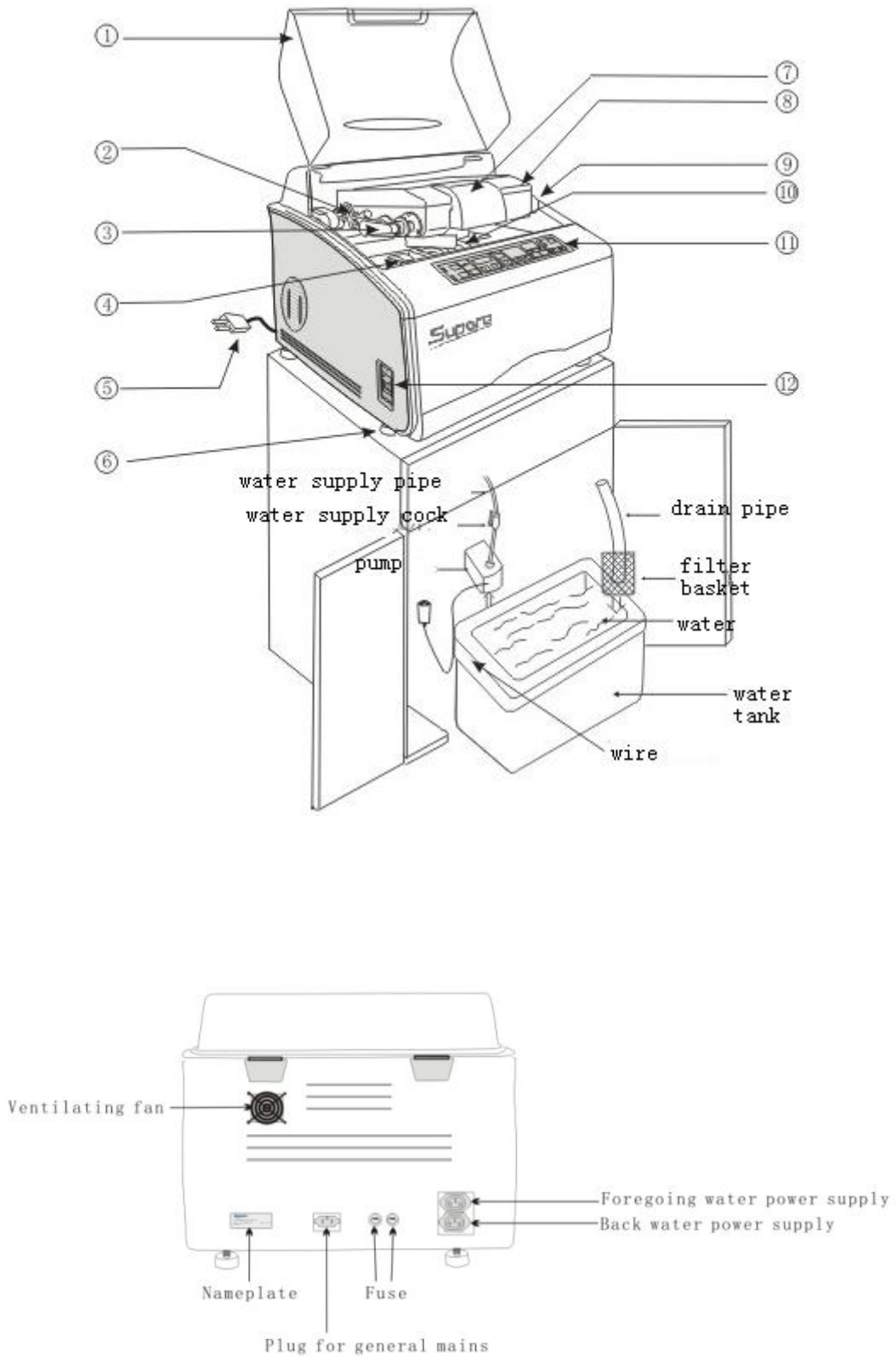

- (1) soundproof cover (2) carriage weight-changing lever
- (3) template retainer (4) carriage backlash sensor
- (5) power cord (6) adjustable cover
- (7) waterproof cover (8) carriage
- (9) lens clamp (10) gear wheel
- (11) operation panel (12) on/off switch

3、LE-300/310/310P Control panel

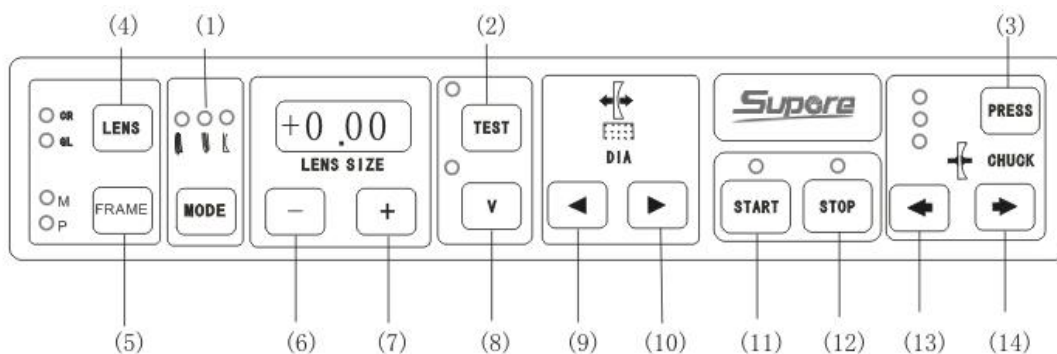

- (1) Beveling and flat edge selector (2) test button
- (3) Clamp pressure selector (4) GL CR selector
- (5) Metal and panel beating selector (6) Minus(-) button
- (7) Plus (+) button (8) Re-edging button
- (9) Shift (left) button (10) Shift(right) button
- (11) Start button (12) Stop button
- (13) Lens-clamping button (14) Lens-loosening button

4、 LE-320/400/420 control panel

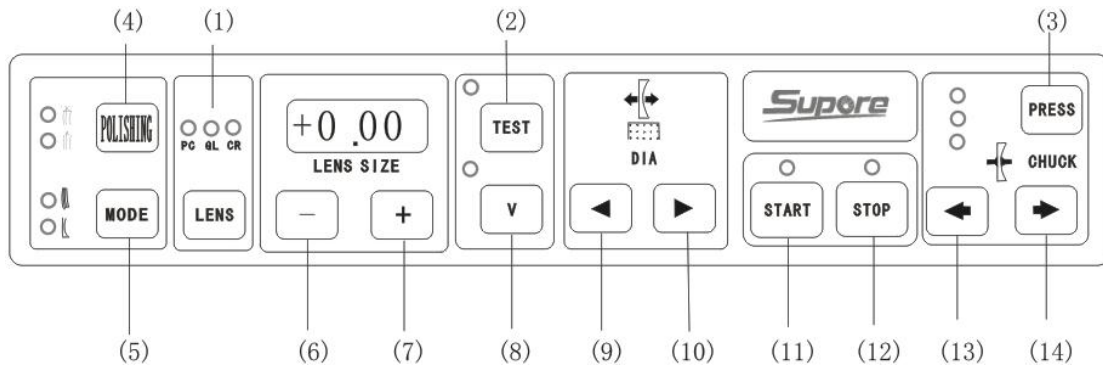

(1) PC、GL、Cr lens selector

(4) Polishing and impolishing selector

(5) Beveling and flat edge selector

Others function same as LE-300/310/310P

二、 HOW TO USE

1、 INSTALLATION

A. installation of main machine

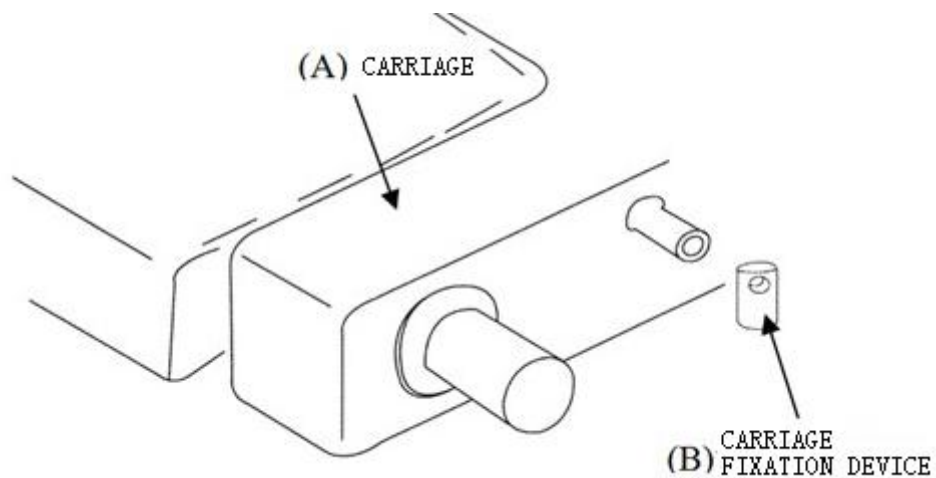

- a. Choose a fixed, horizontal and rigidity platform, ensuring its stability and solidity
- b. Put the machine on the platform as mentioned above
- c. Open the outer casing and dismantle the screw, save the screw carefully.
- d. Plug the power cord and turn on the switch

B. INSTALLION OF WATER TANK AND PIPE

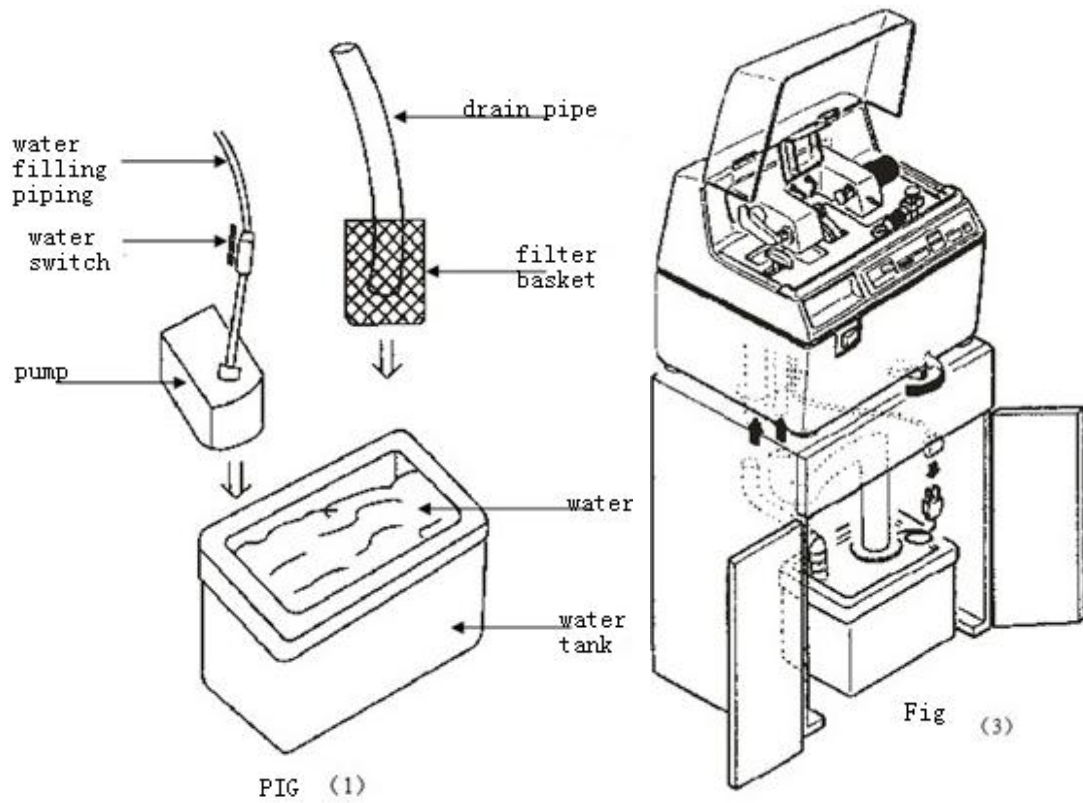

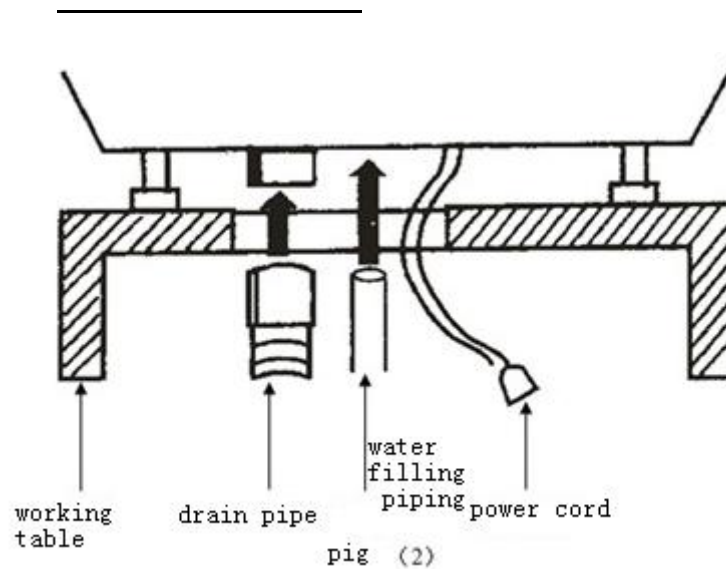

- a. Assemble the tank as illustrated.(see Fig 1)
- b. Connect drain pipe as in Fig2
- c. Show as Fig3 after installion.

please pay attention:

- a.the filter basket should be cleaned regularly
- b.water in tank should be changed frequently
- c. avoiding the pump outlet blocked by the ddirty water
- d. Fix pump power cord outside the tank to avoid it slipping into the water
- e. Fix the pump entirely in the water

2、DEBUGGING



图 (1)

图 (2)

A. Fix a standard template to template A

B. Put the carriage backlashing lever B to the second stage

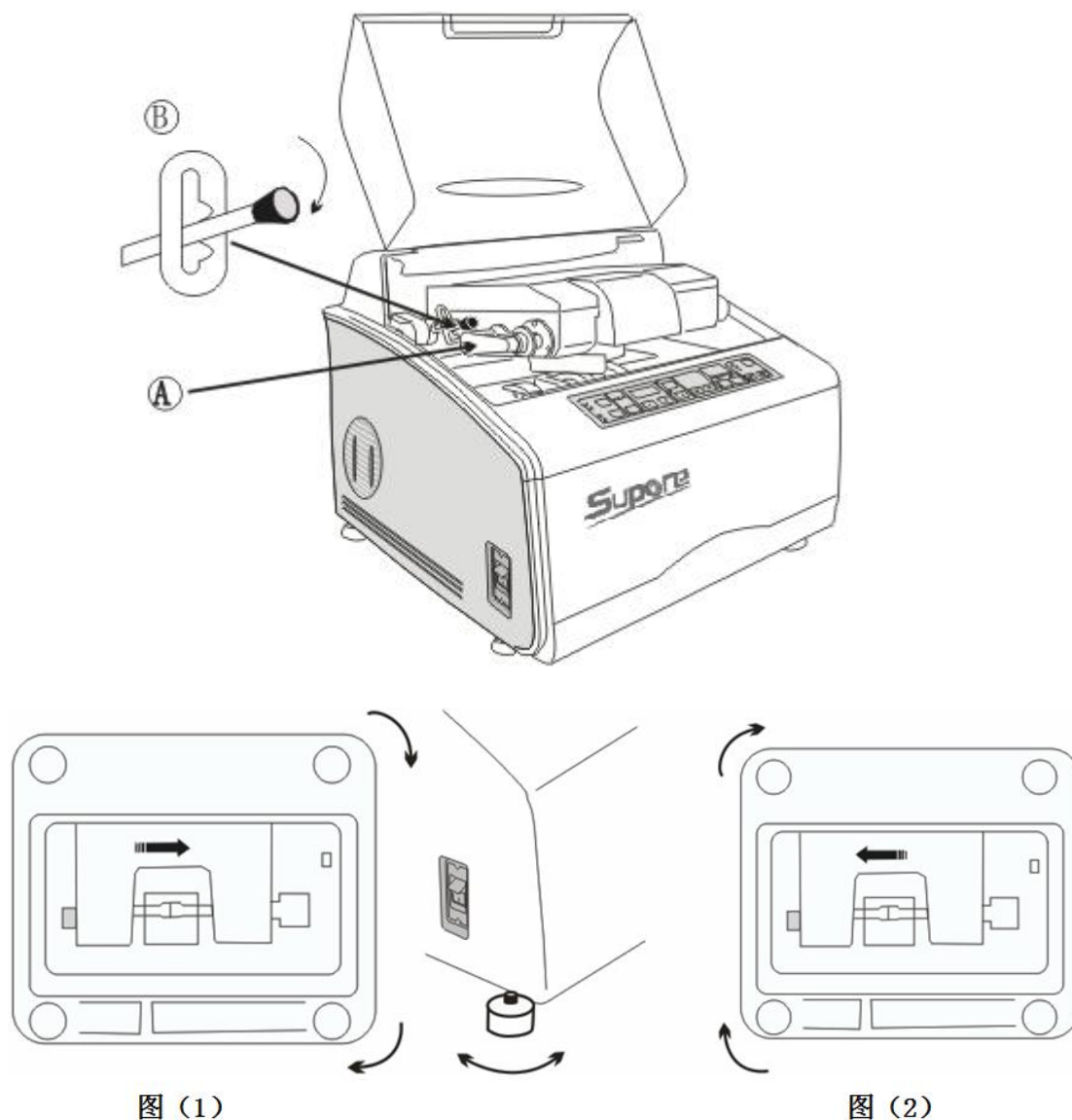
C. Move manually carriage so that it comes just over the gear wheel

E. With this, carriage is level if it doesn't, move either left or right

F. If carriage moves right, turn the right adjustable foot clockwise, as Fig1

G. If carriage moves left, turn the left adjustable foot clockwise, as Fig2

3、 OPERATION PROCEDURES

A. Preparations

- a. Turn power switch on and open water supply cock.
- b. Press (TEST) switch and check that water is supplied

B.Fitting template

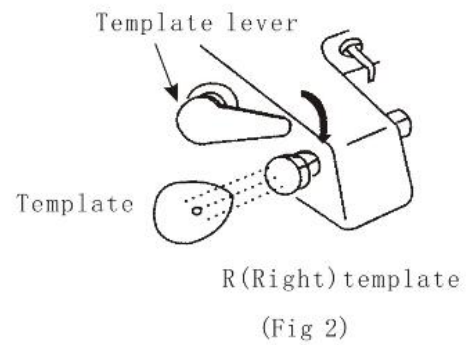
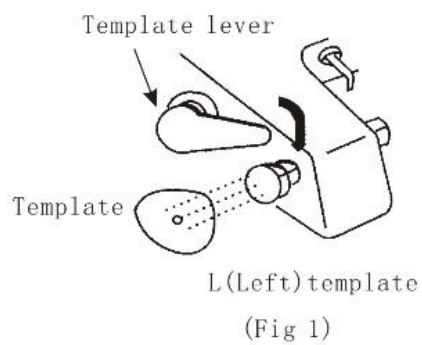

- Fix up a template as illustrated in Fig.1 and Fig.2
- Put left and right templates as illustrate in Fig.1 and Fig.2

C:Fix the lens

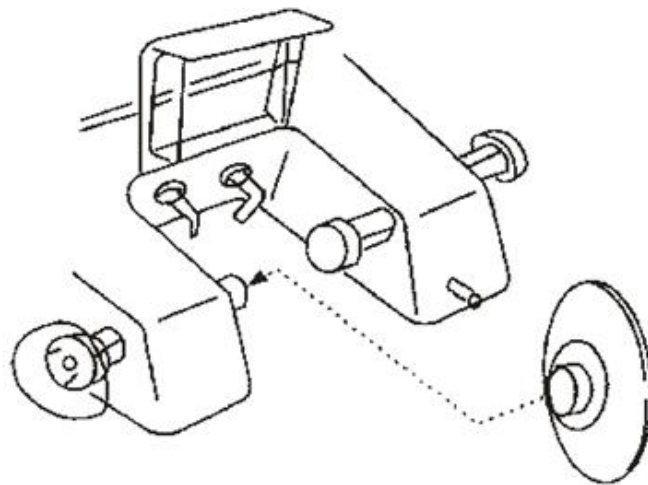

(Fig 3)

Match the upper point of sucker with
the one of shaft. (see Fig.3)

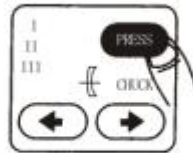

(Fig 4)

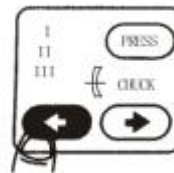

(Fig 5)

D. Clamping lens

1. Select lens clamping with PRESS button see Fig.4

- Select clamp pressure
 - I (low): For high-refractive glass lens
 - II (medium): For glass lens, and CR lens
 - III (high): For CR lens
- Clamp the lens with chunk button
- When press it lightly one time, it will automatically clamp lens
- When hold relax button lightly, clamp will loosen lens

E. Selecting lens

- Press lens selector button to select glass lens or CR lens.

[Note]

It is initially set as GL lens mode when turn on power switch.

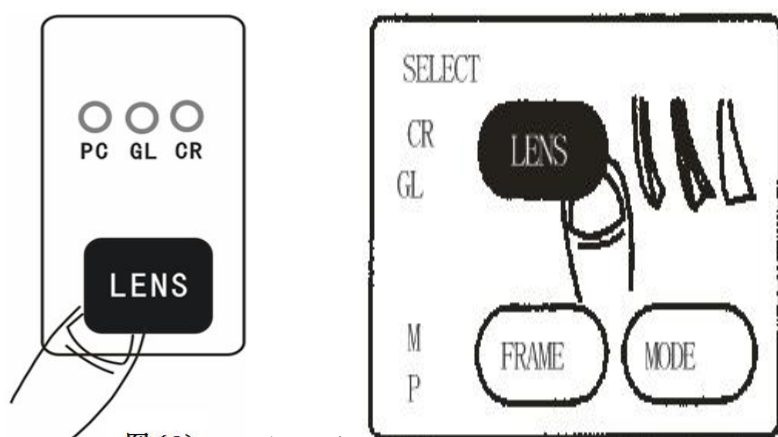

图(6) (Fig.6)

F. Selecting bevel

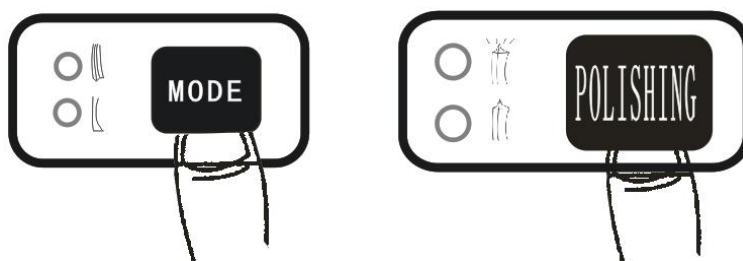

(图 7)

(图 8)

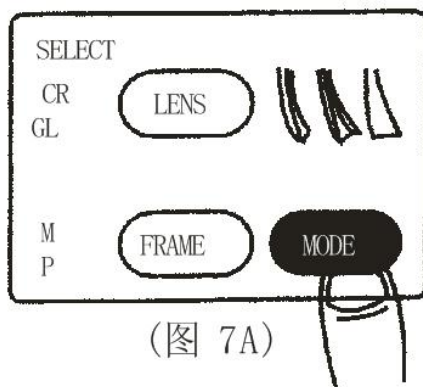

(图 7A)

- a. Press MODE button to alternate modes between bevel and rimless
- b. When “rimless” or “bevel” of LE-320/400/420 is selected, you can also select polishing or not polishing functions (Fig 7 and Fig. 8)

When select the “rimless” of LE-300/310, it will process rimless lens polishing. If you do not want polishing, press “STOP” after the second edger of lens and then the machine will come back to the beginning position. (Fig. 7A)

NOTE:

1. When LE-320/400/420 is polishing with “rimless” or “bevel”, you can choose to turn on the light upside of the button “POLISHING”, the machine will come back to the beginning position after finishing edging.
2. When the machine is not polishing while “rimless” or “bevel”, you can chose to turn on the light under the button “POLISHING”. The machine will come back to the beginning position after finishing edging.

G. Start

- Press START button and process will start

(NOTE)

- Make sure the waterproof cover is closed when edging lens. Otherwise, trouble may be caused
- Close soundproof cover if noise is intrusive

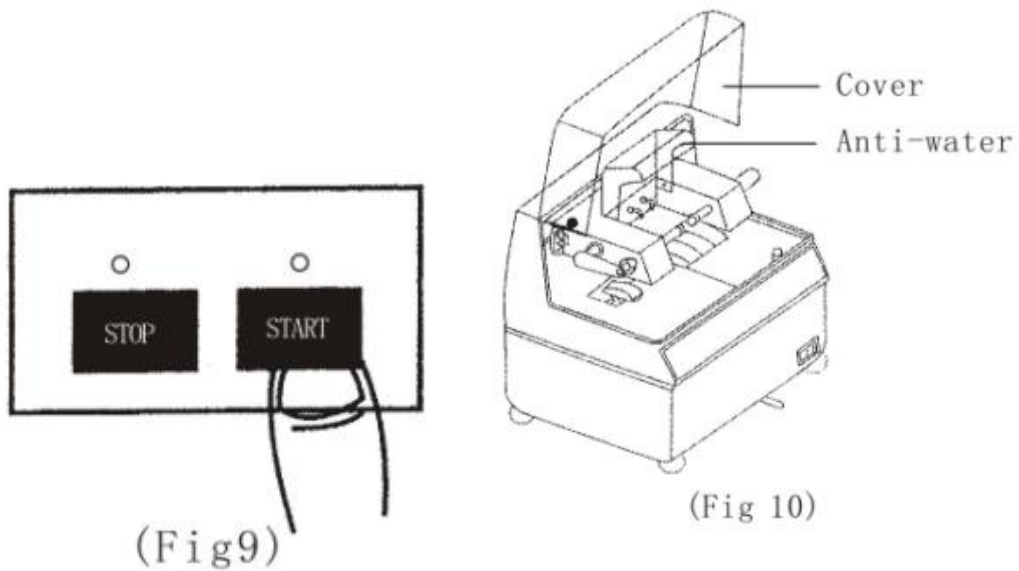

H. Shifting lens position

- Press ◀ and ▶ button to move lens above gear wheel as desired.
- If using it properly to move lens as illustrated gears wheel's life becomes long.(see Fig.11\12)

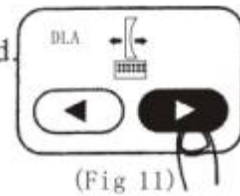

I. Changing lens size

Check the size displayed on the panel if it is as desired

- Use + button to make the lens size larger if its size is smaller after its testing edging.(see Fig.12)
- Use - button to make the lens size smaller if its size is bigger after its testing edging.(see Fig.13)

□NOTE□

- minimum setting size: 0.05mm
- minimum size: -6.00mm
- maximum size: +6.00mm

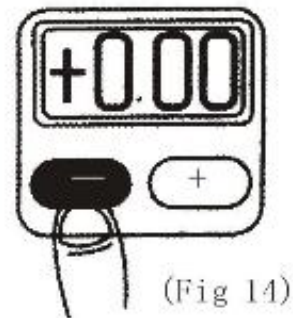
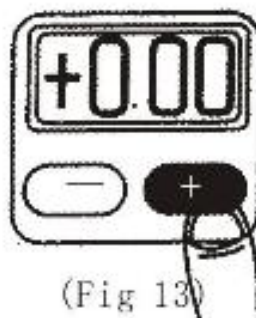
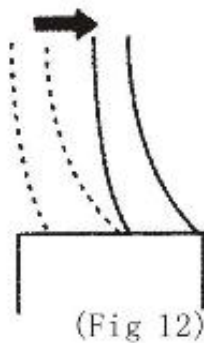

J. Re-edging

- In case that the lens size is still larger after edging
 - ① (see Fig.15): Pressing - button to reset lens size
 - ② (see Fig.15): Press V button, and the machine will re-edging lens on the second wheel according the desired reducing size

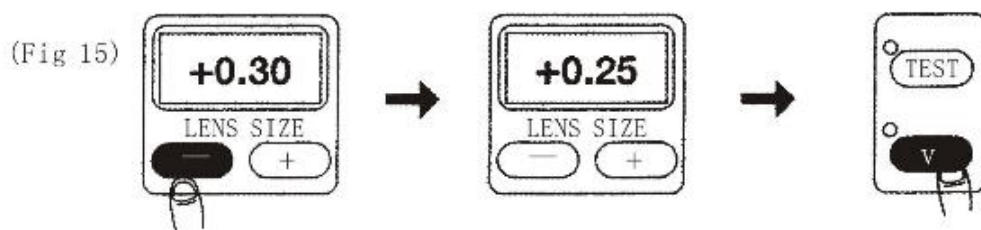

4.Wheel position emendation

(NOTE)

If making an emendation of Section 9, the prior date before emendation is deleted.

Therefore, an accurate setting should be made.

In case that:

- Any part of gear wheel is worn
- There is a wide difference between lens actual size and the digital number
- The maintenance worker repair it

Preparation:

- (1) Fix standard template and gauge.(see Fig.1 and Fig.2)

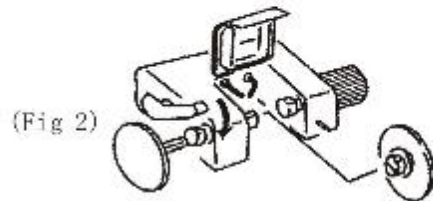

(2) Wheels

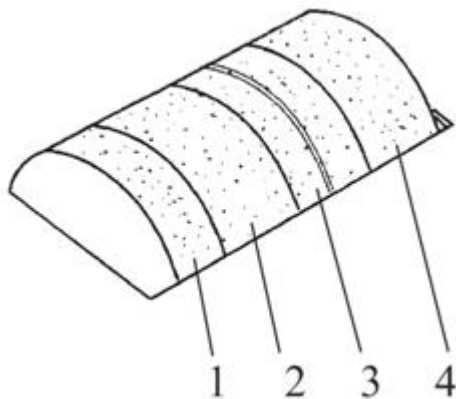

Wheels of LE-300/310/400

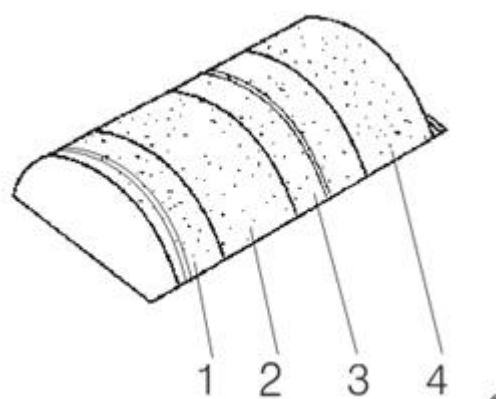

Wheels of LE-320/420

NOTE:

1 is Polishing wheel

In LE-300/310/400 used for polishing resin lenses

In LE-420/320 used for polishing of fiat and beveled style for resin and PC lenses.

2 is Rough grinding wheel: used for roughly grinding glass lens

3 is Fine grinding wheel: used for beveled style or flat style grinding

V groove is for beveled fine grinding

The right side of wheel is for rimless fine grinding

4 is CR rough grind wheel: LE-300/310/320 used for roughly grinding PC lens;LE-400/420 used for roughly grinding PC or resin lens

The calibration of LE-300/310/400

1. Press the button of moving left and right at the same time, then turn on the power.
2. Adjust the V gauge on the fourth wheel by pressing the button of moving left or right, usually it is on left side.
3. Press the button “STOP” to save.
4. Adjust the V gauge on the first wheel by pressing the button of moving left or right, usually it is on left side.
5. Press the button “STOP” to save.
6. Adjust the V gauge on the second wheel by pressing the button of moving left or right, usually it is on left side.

-
7. Press the button “STOP” to save.
 8. Adjust the V gauge on the second wheel, make fine adjustment
(The fine adjustment distance is 0.1mm) by Chunk buttons to let
the V gauge at the deep of V groove.

NOTE: this step is very important and make sure it is correct.

9. Press Re-edging button to see if the gauge is in the deepest of V
groove
10. Press STOP button to save it.
11. Adjust the V gauge by pressing the button of moving left or right,
usually it is on right side.
12. Press STOP button to save it.
13. Turn off the machine.

The calibration of LE-320/420

1. Press the button of moving left and right at the same time, then
turn on the power.
2. Adjust the V gauge on the fourth wheel by pressing the button of
moving left or right, usually it is on left side.
3. Press the button “STOP” to save.
4. Adjust the V gauge on the second wheel, make fine adjustment
(The fine adjustment distance is 0.1mm) by Chunk buttons to let
the V gauge at the deep of V groove.

NOTE: this step is very important and make sure it is correct.

5. Press “Re-edging” button to see if the gauge is in the deepest of V grove
6. Press the button “STOP” to save.
7. Adjust the” V” gauge on the right side of the V wheel by pressing the button of moving left or right, usually it is on left side.
8. Press the button “STOP” to save.
9. Adjust the “V” gauge on the second wheel by pressing the button of moving left or right, usually it is on left side.
10. Press “STOP” button to save it.
11. Adjust the “V “gauge on the second wheel, make fine adjustment (The fine adjustment distance is 0.1mm) by Chunk buttons to let the V gauge at the deep of V grove.

NOTE: this step is very important and make sure it is correct.

12. Press “Re-edging” button to see if the gauge is in the deepest of V grove
13. Press “STOP” button to save it.
14. Adjust the V gauge on the right side of the V wheel by pressing the button of moving left or right, usually it is on left side.
15. Press “STOP” button to save it.
16. Turn off the machine.

3.Maintenance

Renewing water	<ul style="list-style-type: none"> • Renew water periodically after about 100 lenses have been edged.
Cleaning water supply nozzle	<ul style="list-style-type: none"> • Water supply nozzle is readily clogged if longtime supplying water contaminated by edging dust. If
Clearing gear wheels	<ul style="list-style-type: none"> • When the gear wheel is worn, having been edging for longtime, or bevel is not well formed. • In case of that, use a whetstone to sharpen gear wheels. • Press TEST button, and the wheel begins to revolve. • Then, press TEST button again, and wheel will continue revolving. • Sink the whetstone in water for 2-3 minutes. Then press it onto the revolving wheel surface, when its speed is slow down. • Repeat this operation 5 to 10 times. • Don't clean the gear wheel for plastic lens as said above.
Replacing wheels	<ul style="list-style-type: none"> • Portion of the wheel will be destroyed during normal using. • In such a case, whetstone is no use to correct such a wheel. • In this case, replace it with a new one.

Cleaning	
Periodic cleaning	<ul style="list-style-type: none"> • Remove grinding chips from machine using a brush everyday. • Don't flow any water inside, or trouble may be caused.

Moving machines	
ATTENTION	<p>Turn off the power and take the plug out of the plug-seat Separate the water pipe from the machines The machine needs re-adjustment after moving.</p>

After sale service	
Clean the machine	Contact with your sales agent every year after you buy the machine in case it breaks down or lead to other problems

4. Before requesting service

Water is not supplied and gear wheel does not revolve either.	<ul style="list-style-type: none"> • Check if power switch is turned on.
Continuous beeping sound as (peep, peep, peep)	<ul style="list-style-type: none"> • Push carriage slightly right side.
Gear wheel revolves , but water is not supplied.	<ul style="list-style-type: none"> • Check if water supply cock is tightened up. • Check if water supply nozzle is clogged. • Check if tank is filled with water.(to 80% mark) • Check if pump motor revolves well. • Check if pipes are connected well.
Bevel is formed at rear side when normal edging.	<ul style="list-style-type: none"> • Is machine level? • Does grinding wheel work well?
Offcentering occurs.	<ul style="list-style-type: none"> • Make sure that the sucker center is set well, with moisture removed • Make sure that the sucker is not cracked.

5. Specifications

Size: 360×470×500

Weight: 49 Kg

Environment required: 5°C~40°C

Formulated Power: 50-60Hz

Noise: ≤50dB

Main Power: 380W

Power consumption: ≤500W

Voltage: 220V±10%

6. Accessories and Tools

No.	Description	quality
1	Screwdriver	1
2	Hex wrench	1
3	Standard Template	1
4	V Calibration Board	1
5	Suction cup	4
6	Chuck	1
7	Template holder screw	1
8	Fuse	2
9	Warranty Card	1
10	Certificate of quality	1

11	Instruction Manual	1
12	Desiccant	2
13	VCD	1
14	Power line	1